

This document is published in:

IET Intelligent Transport Systems, 2011, Vol. 5, Iss. 1, pp. 60–69

DOI: [10.1049/iet-its.2010.0042](https://doi.org/10.1049/iet-its.2010.0042)

© 2011 The Institution of Engineering and Technology.

# Limitations of positioning systems for developing digital maps and locating vehicles according to the specifications of future driver assistance systems

F. Jiménez<sup>1</sup> J.E. Naranjo<sup>2</sup> F. García<sup>3</sup> J.G. Zato<sup>2</sup> J.M. Armingol<sup>3</sup> A. de la Escalera<sup>3</sup>  
F. Aparicio<sup>1</sup>

<sup>1</sup>University Institute for Automobile Research (INSIA), Universidad – Politécnica de Madrid, Campus Sur UPM, Carretera de Valencia km 7, 28031 Madrid, Spain

<sup>2</sup>Computer Science School, Universidad Politécnica de Madrid, Escuela Universitaria de Informática, Madrid, Spain

<sup>3</sup>Intelligent Systems Laboratory, Universidad Carlos III de Madrid. AVDA. de la Universidad 30, 28911 Leganés – Madrid, Spain

E-mail: felipe.jimenez@upm.es

**Abstract:** Some advanced driver assistance systems require on-the-lane vehicle positioning on accurate digital maps. The combination of high precision global navigation satellite systems and inertial measurement is the most common technique to carry out this precise positioning since in some areas global positioning systems (GPS) signals are lost or degraded. However, real experimental validation of the navigation algorithms (beyond simulation) is one of the most important shortcomings in the state-of-the-art. In this study, a wide set of real experiments have been carried out on real roads, in urban and rural environments, using an instrumented car. A theoretical approach based on the uncertainty propagation law has been set out to evaluate the errors when using only inertial measurement systems and the maximum distance that can be travelled before exceeding the admissible error limits. Results show that it is better to correct GPS positioning when its signal is degraded than to wait until the signal is definitively lost. Furthermore, inertial measurement systems and GPS receivers of different levels of accuracy have been compared in order to determine whether they are suitable for new assistance applications. Experimental data are consistent with the theoretical approach.

## 1 Introduction

New driver assistance applications being introduced in road vehicles are based on the processing of information related to the state of the vehicle, the driver, the road and the environment. For many, digital maps involve expanding the visual horizon beyond what is perceived by the driver and the onboard sensors [1–3]. Some examples that can be found in the literature are a system that tries to optimise fuel consumption by taking advantage of the state of the subsequent stretch [4, 5] and an intelligent speed adaptation system that provides the driver with warnings in order to adapt the speed by considering the accurate road geometry [6]. However, to exploit their potential it is necessary to define a specification of accuracy and detail in these maps and positioning systems at higher levels than those currently used for navigation purposes [7–9]. This issue arises particularly when dealing with advanced driver assistance systems (ADAS) [10–12], in which safety specifications require accuracy and detail in positioning and digital maps. In this regard, of particular interest are the recent findings developed within the eSafety working group on digital maps, a group of experts who seeks to coordinate activities concerning road traffic safety-related elements of digital

map databases, and to bring together relevant stakeholders such as digital map producers, mapping agencies, the automotive industry, public authorities, user organisations, safety authorities, road operators, universities and research institutes [13], and the final results of the subproject of the Prevent EU-funded Integrated Project called Map&ADAS, a subproject whose objectives include developing, testing and validating appropriate methods for gathering, certifying and maintaining attributes to enable ADAS to be equipped to use digital maps as well as a standardised interface between ADAS applications and ADAS map data sources [14].

There are two lines of research: the development of digital maps and positioning the vehicles on those maps. In the first case a common solution is to use digitised paper maps or aerial photographs [15, 16], but when accuracy needs to be combined with fast measurement or when highly detailed maps are required, the solution is to use a datalog vehicle [17, 18]. On the other hand, in the second case, global navigation satellite systems is the most widespread solution, but other solutions can be found (odometry, e.g., when the satellite signal is lost). This paper deals with measurements made using datalog vehicles and two technologies: satellite positioning and inertial measurement systems.

Focusing on these onboard measurement systems, it should be noted that the global positioning system (GPS) alone is not robust enough and metric accuracy cannot be guaranteed for on-the-lane positioning, as some of the new ADAS require [3]. Furthermore, the satellite signal can be lost in some circumstances (driving through tunnels, between high buildings etc.) and important information for new digital maps such as the banking rate cannot be obtained in a direct and accurate way. Despite the preceding ideas, some authors have used GPS positioning to obtain the road geometry. Among these, in [19] the cruising speed is approximately 80 km/h with a 1 Hz sampling frequency, which gives points that are spaced 20 m apart. They use the mean and standard deviation of the lane width measurement when measuring the same route using different lanes, as an indicator of accuracy. In [20], the authors also use a GPS receiver with a 1 Hz sampling frequency and a travel speed of 100 km/h. In both cases the filtering and elimination of erroneous points is required. In [21], the GPS positioning signal is used to integrate the road geometry information into a geographic information system.

Differential correction techniques allow improving GPS accuracy from 10 to 15 m of error to 1 cm error in the best operating conditions. Differential correction consists in adding a second GPS unit in the position calculus. This second GPS, named a base station, is georeferenced and installed in a static infrastructure. The base station calculates its own position using the GPS satellite constellation, taking into account that this error is about 10 m. Once its position has been calculated, the base station compares it with the georeferenced position, obtaining the offset of the positioning error. This offset is sent via state-of-the-art wireless communications to all the connected autonomous GPS devices that work in an operative range, that correct their position using the offset received from the base station. If this differential correction is obtained using only GPS pseudo-range code, it is named differential GPS (DGPS) and can achieve accuracies of around 1–5 m. On the other hand, if it is obtained using the GPS carrier phase information, it is named real time kinematics (RTK) DGPS and its accuracy is between 1 and 10 cm. This last method has been used, among other applications, in autonomous driving systems [22], and in order to increase accuracy in positioning in [23] DGPS with a 0.1 Hz sampling frequency being used. The main limitation of this solution is the accuracy degradation when the distance between mobile receiver and base station increases, because the base station network is not wide enough so distances between the receiver and the nearest one can usually be large. Furthermore, depending on the signal transmission correction technology, the range is limited and can become drastically reduced in the presence of obstacles.

A solution used to overcome this distance limitation is the use of differential correction transmitted via the OMNISTAR satellite constellation. This system transmits this information using geostationary satellites and is received by compatible receivers with a prior subscription. This kind of correction allows GPS receivers to obtain accuracies of between 1 and 5 cm depending on the levels of DGPS service: VBS (virtual base station), HP (high performance) and XP (extended performance). These kinds of systems are used in new generation autonomous vehicles like DARPA grand challenge's KAT-5 [24]. Other solutions for via-satellite differential correction are satellite-based augmentation systems such as the one used by the SciAutonics Team [25]. A second solution is to use the new internet differential correction service NTRIP (networked transport

of RTCM via internet protocol). This service offers differential correction data from a network of base stations across Europe via the internet, adapting the data to the nearest base station to our position. The application of this solution allows ubiquitous RTK navigation and independence of a physical GPS base station. This second solution is the one used in our research, using cellular communications as wireless link.

Unfortunately, previous solutions cannot solve signal degradation or signal losses under adverse conditions (urban environments, trees, high walls near the road etc.). Inertial measurement systems have been seen as a solution to minimise previous limitations by combining both positioning methods. These systems do not have the problems of signal losses and can provide data such as banking rate in a direct way. The authors in [26] use speed measurements and a gyroscopic sensor to deduce the horizontal alignment. Measurements are taken every 16 m and the angular precision is  $1^\circ$ , which can lead to significant errors. Subsequently, a distinction is made between straight lines and curves based on the variation of the yaw angle. The problem arises when accuracy requirements increase, so it is necessary to analyse whether this system is reliable for accurate digital map development and on-the-lane positioning because of the cumulative error that inertial systems present [27]. A comparison of results using a DGPS receiver and a low-cost 2D inertial measurement unit is presented in [18]. In this sense, the use of Kalman filtering is a very widespread solution in order to improve the positioning obtained using different measurement methods [28–31]. Other limitations such as not considering an absolute reference are easily solvable and do not entail additional problems.

This article presents a comparative analysis of methods for digital map development and the estimation of the vehicle's position using GPS and inertial systems, including a wide set of real experiments with real vehicles on public roads, testing several positioning technologies in combination with vehicle to infrastructure communications so that different methods for vehicle positioning and digital map development are compared. Furthermore, it is studied to what extent the cumulative errors of inertial systems are admissible by new ADAS accuracy requirements. Both theoretical and experimental approaches are shown and a novel approach based on the uncertainty propagation law is described. It also raises the comparison between equipment of high- and low-performance characteristics for both applications and it is studied whether they can fulfil new ADAS requirements. In this case, a complete comparison between equipment of different accuracy levels is carried out, so previous results can be used as reference values in order to analyse to what extent low-performance systems are accurate enough for certain ADAS applications. These conclusions related to assistance systems will be highlighted as the paper develops.

## 2 Objectives

Because of the limitations of road geometry measurement and the positioning systems that can be installed on a datalog vehicle, the following objectives have been set out in a theoretical–experimental analysis that combines inertial systems and satellite positioning systems in order to develop digital road maps and to locate vehicles on those maps:

1. Objectives in the research area of digital map development:

- To analyse the reliability of DGPS signals under real conditions in urban and rural environments.
- To determine the cumulative error when using high-performance inertial measurement systems for vehicle positioning or for digital map development, and to establish a travelled distance limit in order to observe new ADAS specifications that require on-the-lane positioning when the GPS signal is lost or degraded. The theoretical approach will be based on the uncertainty propagation law and a wide set of tests has been carried out in order to validate the results.
- To analyse the combination of both sources of information. Operating conditions will be studied in which the GPS is lost and inertial navigation systems need to be used until signal loss is recovered. Errors are evaluated on recovery of the signal.
- The following equipment was used in the trials in urban and rural areas: a Correvit L-CE-non-contact speed sensor to measure speed and the distance travelled, an RMS FES 33 gyroscopic platform to provide measurement of the angles drawn about three axes, and an RTK DGPS Topcon GB-300 receiver with an update frequency of 10 Hz and the possibility of using American GPS and Russian GLONASS. Additionally, this GPS receiver equips built-in universal mobile telecommunications system (UMTS) connectivity (vehicle to infrastructure communications) and access to NTRIP services in order to obtain ubiquitous RTK differential correction.

## 2. Objectives in the research area of vehicle positioning:

- To determine results degradation when low-performance measurement equipment is used and to analyse whether its use is viable in new ADAS applications that require on-the-lane positioning. A distance limit that shows how long the system could work properly without a GPS signal should be estimated.

In these tests, the Xsens MTi-G gyroscopic platform is compared to the RMS FES 33 platform, and the Astech G12, Garmin GPS eTrex H and the GPS receiver included in the Xsens MTi-G equipment. All of them, in an autonomous positioning configuration, are compared to the results provided by the DGPS Topcon GB-300 receiver.

Fig. 1 shows the main characteristics of the equipment that was used in the tests.

## 3 Results in the research area of digital map development: high-performance equipment

When developing digital maps, the use of high-performance equipment can be assumed. In this sense, DGPS receivers and high accuracy inertial systems can be highlighted. Both have been analysed and the deviations between GPS signals and the inertial measurement system results have also been computed. A complete set of tests is now presented under different operating conditions, showing that, apart from theoretical specifications, some limitations of these high-performance systems can appear.

First of all, DGPS was tested in different scenarios. The RTK DGPS Topcon GB-300 receiver was used, with an update frequency of 10 Hz and the possibility of using American GPS and Russian GLONASS. Then a novel theoretical approach based on the uncertainty propagation law was proposed in order to calculate the measurement uncertainty before carrying out the tests. The results were applied to a high-performance inertial measurement system comprising a Correvit L-CE-non-contact speed sensor and an RMS FES 33 gyroscopic platform. Finally, the

combination of both sources of information was analysed in real tests and the coherence of the results with the previous theoretical approach were studied.





### 3.1 DGPS

DGPS can provide very accurate results but the satellite signal can be lost under certain circumstances and the correction signal can be degraded too, so it is necessary to analyse to what extent digital maps can be developed using this information. With this purpose, tests were carried out on urban and rural roads. The quality of positioning is measured, in these tests, as a factor of the signal GPS quality following the standard GPS NMEA convention: type 4 or fixed for centimetric accuracy, type 5 or floating for submetric accuracy and type 1 or autonomous (the device provides positioning without differential correction) for metric accuracy (error of 10–15 m maximum).

Table 1 shows how much time each accuracy level is maintained by the DGPS receiver during seven tests. It should be noted that test conditions and the road environment are heterogeneous. Test 1 was carried out on a flat 300 m long test track without high obstacles nearby. Tests 2–4 were carried out along different highways, placed in an open field, without buildings, mountains, tree canopies or any other element that could obstruct the GPS satellite signal reception. Tests 5–7 were developed in a scenario that is characterised by a lot of buildings and tree canopies along its sides. Fig. 2 shows some characteristic stretches in which the GPS receivers were tested. Exceptionally good results are obtained under controlled conditions on the test track, but, as can be seen, in general, in urban and rural environments, type 4 accuracy level is quite uncommon because time is needed to recover the correction signal after a signal loss. On the other hand, in most cases, type 4 or type 5 is maintained more than half of the time, so submetric accuracy is obtained, and this is enough in most of the applications. However, it is necessary to solve the accuracy problems and signal losses during the rest of the tests, and satellite positioning is not feasible because of the limitations of the present state of technology. Even when using novel base station networks and current telecommunications technologies, DGPS data would not be appropriate enough under the adverse operating conditions that are not uncommon in road environments.

### 3.2 Inertial measurement systems

The trajectory of the vehicle can be obtained using inertial measurement systems that provide the vehicle dynamic behaviour and, assuming that the centre of gravity of the vehicle moves along the lane centre, the digital map is developed. There are several vehicle dynamics mathematical models: some of them consider individual movements because of the complexity of global vehicle behaviour equations in order to obtain analytical expressions [32–34], and others consider all the movements as a whole [35–38]. In this specific case, it is not necessary to use tridimensional models, because the effect of roll and pitch angles can be neglected and only yaw angle should be considered. Fig. 3 shows the vehicle movement between two time moments. If we consider that the  $x$  and the  $y$  axes (absolute reference) coincide with the longitudinal and transversal axes of the vehicle in the initial position, the gyroscopic platform provides the yaw angle ( $\theta_z$ ) relative to that absolute reference. However, the vehicle slip angle ( $\beta$ ) makes that the vehicle

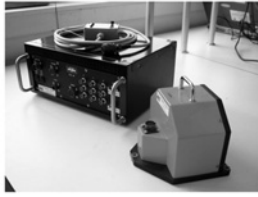
Equipment	Characteristics	Figure
Garmin GPS eTrex H receiver	Autonomous configuration Update frequency: 1 Hz Resolution: ~ 0.5 m Relative cost: 1	
Astech G12 GPS receiver	Autonomous configuration (differential configuration available) Update frequency: 10 Hz Resolution: ~ 1 cm Relative cost: 30	
Topcon GB-300 GPS receiver	Differential configuration Possibility of using GPS + GLONASS Update frequency: 10 Hz Resolution: ~ 1 cm Relative cost: 100	
Xsens MTi-G system (gyroscopic platform + GPS receiver)	Output variables: 3 angles Speed GPS positioning Update frequency (GPS): 1 Hz Resolution (GPS): ~ 0.5 m Accuracy: 1° (angle) Size (cm): 6 x 5 x 3 Relative cost: 40	
Correvit L-CE-non-contact speed sensor	Output variables: Longitudinal speed Range: 1 - 400 km/h Maximum deviation: 0.06 % Size (cm): 15 x 10 x 20 Relative cost: 100	
RMS FES 33 gyroscopic platform	Output variables: 3 angles 3 angular rate 3 long. accelerations Accuracy: 30'' (angle) 0.007°/s (rate) 0.01 % (acceleration) Size (cm): 15 x 15 x 20 + 30 x 25 x 15 Relative cost: 900	

**Fig. 1** Instrumentation characteristics

moves along the direction  $(\theta_z + \beta)$  relative to the absolute reference.

Taking into account previous considerations, the path can be computed by means of the following equations:

$$X \text{ coordinate: } x_n = x_{n-1} + \Delta x_n = x_{n-1} + v_n \Delta t_n \cos(\theta_{zn})$$

$$= \sum_{i=1}^n v_i \Delta t_i \cos(\theta_{zi} + \beta) \quad (1)$$

**Table 1** DGPS accuracy levels during tests (percentage of time in each accuracy level)

	Test 1	Test 2	Test 3	Test 4	Test 5	Test 6	Test 7
type 4	100.0	29.6	53.6	73.4	11.4	23.0	7.7
type 5	0.0	19.0	16.2	20.8	25.5	31.0	48.5
type 1	0.0	38.1	15.0	4.5	7.2	13.7	24.1
no signal	0.0	13.3	15.2	1.2	55.9	32.3	19.7



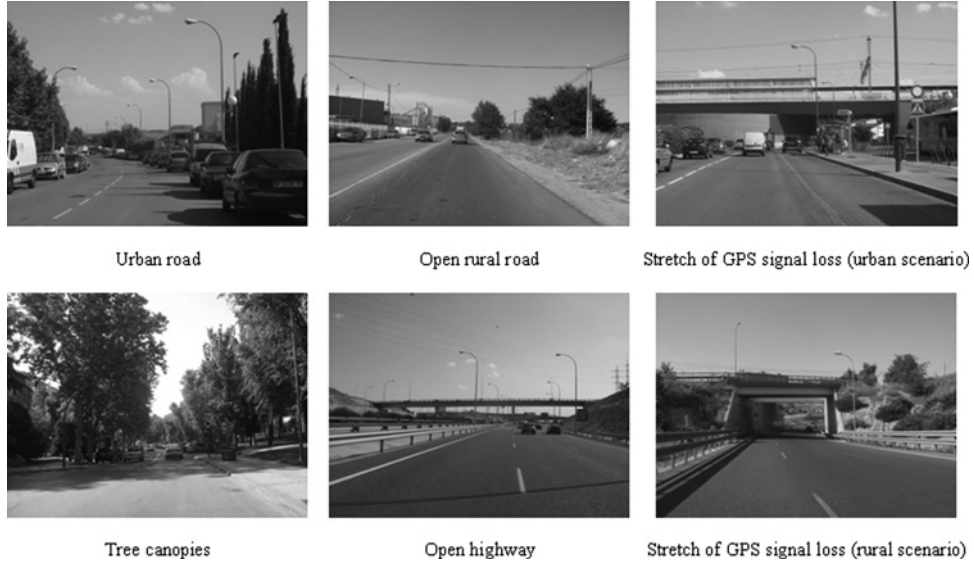

**Fig. 2** Scenarios used for DGPS evaluation

$$\begin{aligned}
 Y \text{ coordinate: } y_n &= y_{n-1} + \Delta y_n = y_{n-1} + v_n \Delta t_n \sin(\theta_{zn}) \\
 &= \sum_{i=1}^n v_i \Delta t_i \sin(\theta_{zi} + \beta)
 \end{aligned} \quad (2)$$

$$\alpha_r = \frac{v^2 P_r}{gR K_{\alpha r}} \quad (7)$$

In order to obtain the vehicle slip angle, a two-wheel vehicle model can be used (Fig. 4). The tires slip angles are given by

$$\alpha_f = \delta - \beta - \frac{l_1 \dot{\theta}_z}{v} \quad (3)$$

$$\alpha_r = -\beta + \frac{l_2 \dot{\theta}_z}{v} \quad (4)$$

so, the vehicle slip angle can be directly related to the tires slip angles

$$\beta = (\delta - \alpha_f) \frac{l_2}{l_1 + l_2} - \alpha_r \frac{l_1}{l_1 + l_2} \quad (5)$$

Anyway, the tires slip angles depend on the lateral force and the tires lateral stiffness ( $K_{\alpha}$ ) and are given by the following equations

$$\alpha_f = \frac{v^2 P_f}{gR K_{\alpha f}} \quad (6)$$

X - Y : absolute reference  
d : distance travelled between the two measurements  
v : cruising speed  
 $\Delta t$  : time between the two measurements  
 $\theta_z$  : yaw angle  
 $\beta$  : vehicle slip angle

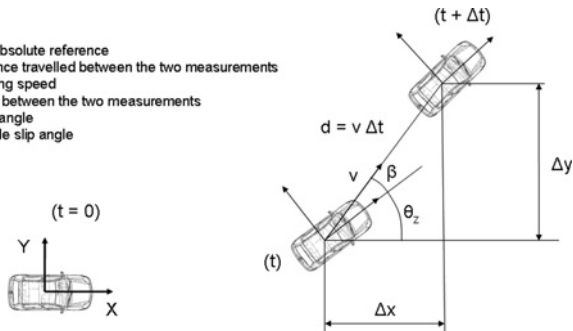
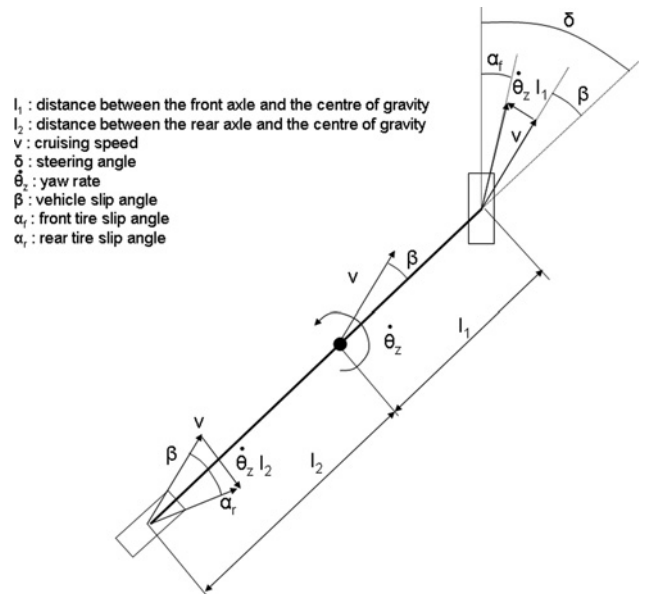

**Fig. 3** Vehicle trajectory calculation

where  $R$  is the curve radius and  $P_f$  and  $P_r$  represent the weights on the front and rear axles, respectively.

This way, using (6) and (7) in (5), the coordinates of the trajectory can be obtained by means of (1) and (2). However, when developing digital maps, in order to follow the lane centre correctly with the datalog vehicle, the cruising speed should be low so the vehicle slip angle is negligible and (1) and (2) can be simplified, giving

$$\begin{aligned}
 X \text{ coordinate: } x_n &= x_{n-1} + \Delta x_n = x_{n-1} + v_n \Delta t_n \cos(\theta_{zn}) \\
 &= \sum_{i=1}^n v_i \Delta t_i \cos(\theta_{zi})
 \end{aligned} \quad (8)$$



**Fig. 4** Two-wheel vehicle model

Y coordinate:  $y_n = y_{n-1} + \Delta y_n = y_{n-1} + v_n \Delta t_n \sin(\theta_{zn})$

$$= \sum_{i=1}^n v_i \Delta t_i \sin(\theta_{zi}) \quad (9)$$

The main problem of this method is that the error of this measurement is cumulative. It is necessary to evaluate the magnitude of this error. Although there are methods that evaluate the errors committed after a certain measurement, in the literature there is no method that evaluates an upper limit of the uncertainty that could be expected. The following novel theoretical approach tries to estimate the digital map measurements of uncertainty and to estimate the maximum distance that can be travelled without exceeding an error limit.

The uncertainty of results using inertial systems can be evaluated by applying the uncertainty propagation law [39, 40]. The global uncertainty of an indirect output variable  $\alpha$  defined as  $\alpha = f(\beta_1, \beta_2, \dots, \beta_N)$  is given by the following general expression

$$u^2(\alpha) = \sum_{i=1}^N \sum_{j=1}^N \left( \frac{\partial \alpha}{\partial \beta_i} \right) \left( \frac{\partial \alpha}{\partial \beta_j} \right) u(\beta_i, \beta_j)$$

$$= \sum_{i=1}^N c_i^2 u^2(\beta_i) + 2 \sum_{i=1}^N \sum_{j=i+1}^N c_i c_j u(\beta_i, \beta_j) \quad (10)$$

where  $u(\beta_i)$  is the uncertainty component of the input variables,  $u(\beta_i, \beta_j)$  is the covariance when input variables are correlated and  $c_i$  is the sensitivity coefficient of each uncertainty component, given by the equation

$$c_i = \left( \frac{\partial \alpha}{\partial \beta_i} \right) \quad (11)$$

When applying (10) to the calculation of the uncertainty of the  $x$  and  $y$  coordinates, it may be assumed that the input quantities (longitudinal speed, yaw angle and time interval) are not correlated because they come from different equipment, so the terms involving covariances are zero and the previous equation can be applied only taking into account the uncertainties of the input variables.

Depending on the application for which the digital map or the vehicle positioning is going to be used, it is critical to establish an admissible upper limit of the error committed. Assuming the uncertainty of measurement in the yaw angle and the time between the two measurements are constant and the speed uncertainty is linear in respect of the speed value, we can consider that

$$u(\Delta t_i) = K_1 \quad (12)$$

$$u(\theta_{zi}) = K_2 \quad (13)$$

$$u(v_i) = K_3 v_i \quad (14)$$

The case of the yaw angle is justified because the sensor calibration results show that the uncertainty is independent of the yaw value. Furthermore, the almost linear relationship between the speed measurement uncertainty and the speed value is also obtained from the calibration of the sensor. Finally, the uncertainty of the measurement of the time between two samples can be considered constant because it mainly depends on the resolution of the

acquisition system and it is independent of the acquisition frequency. Using these assumptions in the expression of the sum of uncertainties of the  $X$  and  $Y$  coordinates and considering that the time between the two measurements is constant, the following result is achieved

$$u^2(x) + u^2(y) = K_3^2 \sum_{i=1}^n v_i^2 \Delta t_i^2 + K_1^2 \sum_{i=1}^n v_i^2 + K_2^2 \sum_{i=1}^n v_i^2 \Delta t_i^2$$

$$= (K_1^2 + (K_2^2 + K_3^2) \Delta t^2) \sum_{i=1}^n v_i^2 \quad (15)$$

In order to find a higher limit for the uncertainty, a constant maximum speed is considered, giving

$$u^2(x) + u^2(y) = (K_1^2 + (K_2^2 + K_3^2) \Delta t^2) n v^2$$

$$= (K_1^2 + (K_2^2 + K_3^2) \Delta t^2) \frac{dv}{dt} \quad (16)$$

where  $d$  is the distance travelled. From this equation it is deduced that the distance that can be travelled without the figure for uncertainty exceeding an admissible limit  $u^2(x) + u^2(y) \leq L^2$  is equal to

$$d \leq \frac{L^2 \Delta t}{(K_1^2 + (K_2^2 + K_3^2) \Delta t^2) v} \quad (17)$$

The previous equation provides the evaluation of the uncertainty in the measurement of the road geometry before making the measurement (a priori evaluation), so the applied means can be analysed in order to assess whether they are suitable for the specifications. Hence, for example, ADAS applications that require on-the-lane positioning enforce an upper bound for uncertainty in the position as being equal to the lane width and this implies a very restrictive situation as regards the maximum distance that can be travelled using only inertial systems for positioning. The calculated distance depends on the speed and the sampling rate, apart from the characteristics of the instrumentation, because they are the variables that appear in the position uncertainty calculation. Note that the distance increases when reducing the speed and presents a maximum value on a specific rate that depends only on the characteristics of the instrumentation. This peak value appears because low sampling rates do not take into account the variations in input variables over a long time, and high sampling rates provide a large number of compounded errors. Finally, it should be taken into account that the upper limit increases in a quadratic way when increasing the positioning tolerance and this fact significantly reduces the demands on the instrumentation.

### 3.3 Combination of DGPS and high-performance inertial measurement systems

As previously mentioned, a widespread solution to deal with the limitations of each positioning system separately is the combination of GPS positioning and inertial sensors. The algorithms developed for data fusion are based on determining the confidence level of each measure. Taking into account the satisfactory results of DGPS when type 4 accuracy level is achieved, it should be analysed in which situations inertial sensors can improve results. Two extreme situations can be distinguished: (i) the inertial measurement

system is used only when the GPS signal is lost; and (ii) the inertial measurement system is used when GPS accuracy is degraded, before losing the signal. Of course, Kalman filters consider intermediate situations and good results are achievable when combining both sources of information but some limitations can be found when the prediction step only relies on inertial systems over a long time. The situation that we analyse is similar to signal losses when entering a tunnel or other circumstances without a GPS signal, which is one of the most adverse conditions that can happen. In this situation, signal degradation is expected before signal loss. In the first solution, the last point before the GPS signal is lost and the first point after recovery does not usually present a high level of accuracy, so quite a high degree of uncertainty in GPS positioning is expected. For this reason, a better solution might be to use inertial positioning in the segment where accuracy degrades and not to wait until the signal is lost, but, in this case, longer distances should be covered using inertial measurement systems (second solution). An intermediate and probably better solution is the implementation of a Kalman filter that combines positioning results from the GPS signal and the inertial system data. But the objective now is not to find the optimal solution, but to show the influence of considering more or less accurate reference points when using inertial systems to estimate the path and to see the consistency with the results of the theoretical approach of Section 3.2.

In order to compare the results provided by both the extreme situations previously stated, tests were carried out in urban and rural areas using the Correvit L-CE-non-contact speed sensor, the RMS FES 33 gyroscopic platform and the DGPS Topcon GB-300 receiver that can reach centimetric accuracy under certain conditions, and that includes built-in UMTS connection and NTRIP service access. The performance analysis is carried out comparing the final point  $N$  of the path computed using the inertial system with the GPS positioning, considering that the initial point of this segment is taken as the origin.

Fig. 5 shows differences in the final points of road segments between the positioning by GPS signal and the positioning obtained using inertial measurement systems in the two situations. As can be seen, the consideration of a more reliable starting point for calculation using inertial measurements significantly improves the results despite the fact that the distance travelled using only the inertial measurement system is longer in this second situation. Of course, a compromise should be found between the relative error and the distance in order to minimise the cumulative error, because, in some cases, the recovery of a type 4 GPS

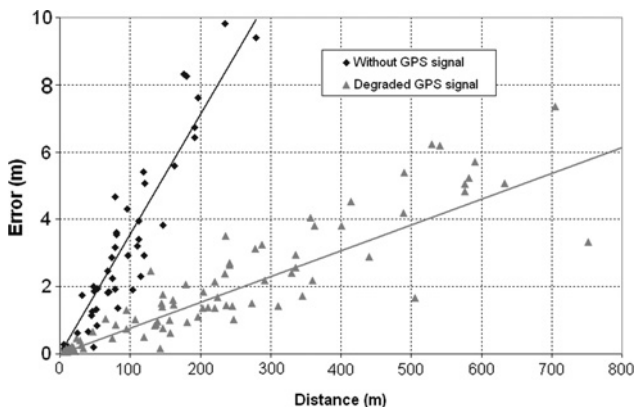

**Fig. 5** Positioning error using the inertial measurement system when the GPS signal is lost or degraded

signal can need more time than expected and the distance travelled can increase significantly.

More specifically, in the first case, errors of 6% of the distance travelled without a GPS signal are found (average value and standard deviation of  $3.2 \pm 1.1\%$ ) but it should be noted that we cannot say if the first difference is caused by the cumulative error of the inertial system or the GPS signal. On the other hand, in the second case, prior uncertainty is not present because centrimetric GPS accuracy is guaranteed and discrepancies are around  $0.9 \pm 0.4\%$ , a lower value than in the first case owing to the fact that the influence of GPS errors has been removed. These results are consistent with the conclusions derived from (17) when calculations are carried out when GPS signal accuracy is degraded, because shorter distances than the calculated upper limit for guaranteeing on-the-lane positioning always provide errors that are lower than the lane width. However, this fact does not occur when using the inertial system data when the GPS signal is lost, because signal degradation before and after signal losses leads to very high uncertainty values.

#### 4 Results in the research area of vehicle positioning: low-performance equipment

Nowadays, digital map development can justify using this high-performance equipment, but present applications of vehicle positioning do not justify the expense of including DGPS or high-performance inertial sensors, such as the ones presented in the previous section. For this reason, it is useful to analyse the performance of low-cost systems for determining vehicle path under normal driving conditions.

Several tests have been carried out comparing the Xsens MTi-G equipment, which includes a gyroscopic platform and a GPS receiver, other two GPS receivers (the Astech G12 GPS receiver working at 10 Hz and the Garmin GPS eTrex H working at 1 Hz), both in an autonomous configuration, and the Topcon GB-300 receiver in a differential configuration that is taken as the reference one. Furthermore, in the same tests, results of the low-performance Xsens platform are compared with the ones provided by the RMS FES 33 platform. These tests include trajectories on the University Institute for Automobile Research test track and routes along the University Campus and rural roads in order to test the systems under different operating conditions.

##### 4.1 GPS positioning

Fig. 6 shows one of the trajectories on the test track and the comparison between all the GPS receivers involved in the

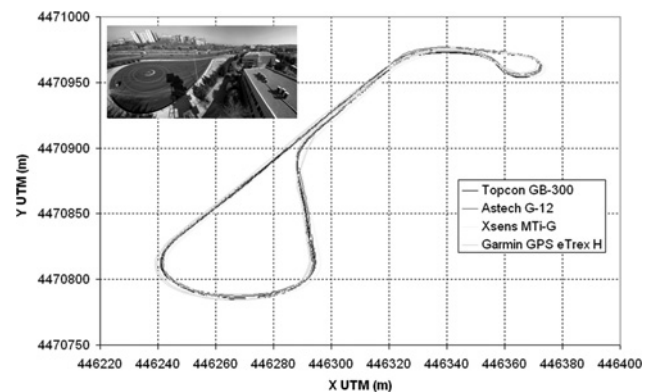
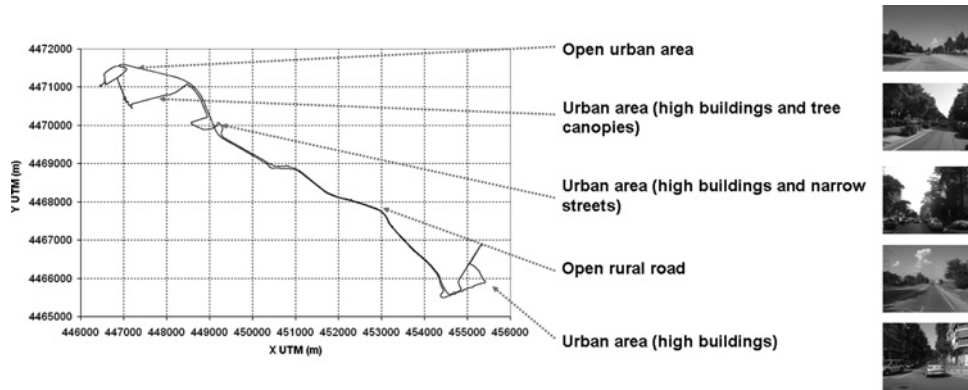

**Fig. 6** Comparison of trajectories obtained by different GPS receivers



**Table 2** Differences in the GPS positioning during the test on the test track (reference value: results of DGPS Topcon GB-300)

Equipment		Astech G-12		Xsens MTi G		Garmin eTREX	
		Horiz.	Vert.	Horiz.	Vert.	Horiz.	Vert.
error value	mean (m)	0.66	-2.56	0.92	58.45	0.57	-5.57
	std. dev. (m)	0.55	1.17	0.59	1.72	0.46	5.00

**Fig. 7** Test trajectory that combines urban and rural areas

tests. The results are quite accurate in all cases if the DGPS signal is taken as the reference value because type 4 level positioning is almost guaranteed, and differences are admissible for their use in new ADAS applications that require on-the-lane positioning (Table 2). The case of Xsens MTi-G equipment is special because it integrates a gyro and a GPS receiver, so it combines both sources of information by means of a Kalman filter, but no significant improvement in results is appreciated because of the low performance of the gyro. The largest differences arise when the vertical magnitude is considered. In this case, DGPS receivers present a more accurate and repetitive behaviour. However, this situation is not very relevant because vertical positioning is not crucial, in general, and the combination of horizontal positioning and accurate digital maps can provide that information if necessary.

In any case, in more realistic paths, differential correction does not provide type 4 accuracy level all the time. For this reason, when this accuracy level is not achieved, the difference between receivers cannot be ascribed to only one of them. Furthermore, the analysis of the signal recovery time after a signal loss is interesting, because inertial

**Table 3** Signal recovery time after a signal loss referred to the time required by the Topcon GB-300 receiver

Equipment		Astech G-12	Garmin eTREX
recovery time	mean (s)	5.49	-1.46
	std. dev. (s)	6.10	2.21

systems should be used during that time and cumulative error should be taken into account. Fig. 7 shows a trajectory that combines urban and rural areas, and different areas are distinguished. Table 3 shows the signal recovery time referred to the time required by the Topcon GB-300 receiver (negative times mean a higher recovery speed of the analysed receiver). There are not clear data tendencies but it was found that the low-performance Garmin eTREX receiver can recover the signal more quickly but it is also prone to short losses.

Table 4 contains the positioning differences between receivers in the different possibilities of accuracy of the DGPS receiver. As can be seen, these differences are higher when type 4 accuracy level is not achieved, because of the lower quality of the reference and the worse operating conditions of every receiver. According to the results obtained with the two low-performance receivers, only the Astech G 12 receiver can guarantee on-the-lane positioning on those road stretches where the DGPS achieves the highest accuracy level. In other situations, the measurement uncertainty is greater than the lane width and the low-cost Garmin eTREX receiver cannot provide accurate enough results even under good operating conditions. It should be noted that in these tests the Xsens MTi G equipment has not been considered because it comprises the GPS receiver and the gyroscopic platform and it combines both when signal losses occur.

## 4.2 Inertial measurement systems

Finally, path calculation using inertial measurement systems is completed. Results of the path carried out on the test

**Table 4** Differences in the GPS positioning during the test in normal driving conditions (reference value: results of DGPS Topcon GB-300)

Equipment		Astech G-12			Garmin eTREX		
		Type 1	Type 5	Type 4	Type 1	Type 5	Type 4
error value	mean (m)	11.47	5.18	2.48	14.19	12.31	10.09
	std. dev. (m)	8.18	5.30	2.61	7.53	7.46	7.45

track are shown in Fig. 8 and Table 5 (three laps and a total length of 1581 m). It can be seen that cumulative errors with low-performance systems are significantly larger than with high-performance ones. It should be noted that, using the RMS FES 33 gyroscopic platform high-performance inertial system, 231 m was the upper limit of the distance for guaranteeing on-the-lane positioning that can be travelled using only the inertial measurement system and type 4 accuracy level of the DGPS signal before and after calculation by means of those sensors. Furthermore, the theoretical approach provides an estimation of the maximum error on the whole trajectory (9.14 m). There is a difference of 4.82% when comparing this figure with the experimental one, but we should keep in mind two limitations of the theoretical approach: (i) equations (8) and (9) are valid when lateral accelerations are low, situations in which it is admissible not to consider the vehicle slip angle, so this fact underestimates the final uncertainty when speed in curves increases, and (ii) equation (17) provides an upper limit considering the maximum cruising speed for a priori evaluation, but uncertainty calculation after measurements should be based on (10). Results are significantly worse when a low-performance gyro is used, such as the one integrated in the Xsens MTi-G equipment. In this case, navigation relies mainly on the GPS signal so inertial measurement should be used only during short signal losses or during short signal degradations, applying a Kalman filter. It can be noted that the results of Fig. 6 are not so bad when combining both GPS and inertial information in a scenario without GPS signal losses.

The upper distance limit is markedly reduced if a worse GPS accuracy level is considered for the starting point (e.g. when differential correction is not used, a situation that is quite common) or higher uncertainty inertial equipment is used, so this makes non-viable the use of this kind of low-performance inertial system during more than 5–6 s in ADAS applications that require a high accuracy level of vehicle positioning. These results can be extrapolated to

other tests because test conditions (road type, road surroundings etc.) do not have any significant influence on the results provided by the inertial measurement systems.

## 5 Conclusions

In this paper, two aspects have been considered simultaneously regarding the positioning of vehicles: the positioning itself and the digital map development on which this positioning is applied. New ADAS applications imply demanding accuracy requirements for both of them. However, it can be assumed that the construction of the digital map is more restrictive because it requires a greater depth of some variables such as banking and ramps. In addition, providing detailed mapping can reduce the effect of errors in positioning during vehicle movements.

A good solution that provides accurate results in DGPS, but it is not robust enough (even when the most novel technologies are used for signal correction, adverse operating conditions lead to correction degradation) and other complementary methods such as inertial measurement systems should be introduced. According to the results obtained, in most GPS signal losses, it is preferable to use inertial measurements not only in the GPS loss segment but in the complete segment with degraded accuracy, and better results are obtained despite the fact that longer distances are considered. However, despite it being a better solution, to apply this criterion, it is necessary for this degradation not to take too much distance in order not to include significant cumulative errors. For this reason, a compromise criterion should be considered. Furthermore, it should be noted that even in the best case of a proprietary base station for differential corrections, signal recovery problems remain when several GPS losses occur near to each other, and this makes correction using inertial systems more difficult and less accurate. In order to estimate an upper limit of the distance that can be travelled without a GPS signal, trusting only in inertial systems data, a novel theoretical approach based on the uncertainty propagation law has been set out. Experimental data validated its results.

The previous high-cost equipment is appropriate for developing digital maps but for vehicle locating it should be noted that the use of DGPS positioning is not common in road vehicles nowadays and involves a high cost, as well as high-performance inertial sensors, and present applications do not justify the expense of this equipment. Low-cost GPS receivers can provide enough accuracy for most of the ADAS applications, mainly on  $x$  and  $y$  coordinates, but not on the  $z$  coordinate, in which errors are very high. For this variable, differential correction can lead to considerable improvements in the results. It should be noted that this improvement is only useful for digital map developments, but is not completely necessary for vehicle positioning on them. Low-cost gyroscopic platforms involve large errors in yaw measurement, so they probably do not provide the accuracy levels required by the new ADAS applications that need on-the-lane positioning because cumulative error on the  $x$  and  $y$  coordinates become inadmissible very soon, as tests and the theoretical approach show. For this reason, only high-performance systems can be used for digital map development, and low-cost inertial systems can be used to locate vehicles when GPS signal losses are very short or low levels of accuracy in that positioning are required (e.g. to know if a vehicle has taken a certain diversion inside a tunnel without distinguishing the lane it is travelling along).

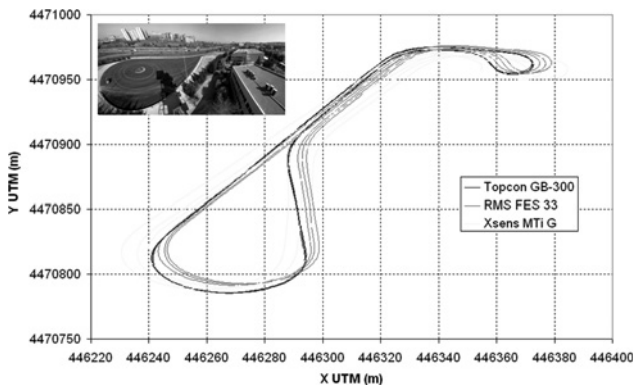

**Fig. 8** Comparison of trajectories using inertial measurement systems

**Table 5** Differences in the positioning using inertial systems (reference value: results of DGPS Topcon GB-300)

Equipment		RMS FES 33	Xsens MTi G
error value	mean (m)	2.23	4.32
	std. dev. (m)	1.98	3.03
	max. diff. (m)	8.72	12.53

## 6 Acknowledgments

The work reported in this paper has been partly funded by the Spanish Ministry of Science and Innovation (SIAC project TRA2007-67786-C02-01 and TRA2007-67786-C02-02) and the CAM project SEGVAUTO.

## 7 References

- 1 Njord, J., Peters, J., Freitas, M., *et al.*: 'Safety applications of intelligent transportation systems in Europe and Japan'. Federal Highway Administration, US Department of Transportation, 2006
- 2 Wevers, K., Lu, M.: 'Digital maps, driving systems and traffic safety: the data chain for in-vehicle map databases'. Proc. Sixth European Congress and Exhibition on Intelligent Transport Systems and Services, Aalborg, 18–20 June 2007
- 3 Jiménez, F., Naranjo, J.E.: 'Nuevos requerimientos de precisión en el posicionamiento de vehículos para aplicaciones ADAS (in Spanish)'. *Dyna Ingeniería e Industria*, 2009, **84**, (3), pp. 245–250
- 4 Reichart, G., Friedmann, S., Dorrer, C., Rieker, H., Drechsel, E., Wermuth, G.: 'Potentials of BMW driver assistance to improve fuel economy'. Proc. of the FISITA World Automotive Congress, Paris, 27 September–1 October 1998
- 5 Venhovens, P.J.T., Bernasth, J.H., Löwenau, J.P., Rieker, H.G., Schraut, M.: 'The application of advanced vehicle navigation in BMW driver assistance systems', SAE Paper No. 1999-01-0490, SAE, 1999
- 6 Jiménez, F., Aparicio, F., Páez, J.: 'Evaluation of in-vehicle dynamic speed assistance in Spain: algorithm and driver behaviour', *IET Intell. Transp. Syst.*, 2008, **2**, (2), pp. 132–142
- 7 Noronha, V., Goodchild, M.F.: 'Map accuracy and location expression in transportation – reality and prospects', *Transp. Res. C, Emerg. Technol.*, 2000, **8**, (1), pp. 53–69
- 8 Baum, G.: 'The infrastructure and evolution of mapmaking'. Proc. Tenth World Congress and Exhibition on Intelligent Transport Systems and Services, Madrid, 16–20 November 2003
- 9 Organisation for Economic Co-operation and Development: 'Road safety. impact of new technologies' (OECD Publications, 2003)
- 10 T'Siobbel, S., van Essen, R.: 'The map enabled ADAS future'. Proc. FISITA World Automotive Congress, Barcelona, 23–27 May 2004
- 11 Lu, M., Wevers, K., van der Heijden, R., Heijer, T.: 'ADAS applications for improving traffic safety'. Proc. IEEE Int. Conf. on Systems, Man and Cybernetics, The Hague, The Netherlands, 10–13 October 2004
- 12 Pandazis, J.C.: 'NEXTMAP: investigating the future of digital maps databases'. NEXTMAP UE Project Paper 2183, 2006
- 13 eSafety Forum. 'Digital maps working group final report'. European Commission (eSafety Forum), Brussels, 2005
- 14 T'Siobbel, S., Otto, H.U., Kopp, D., *et al.*: 'Map&ADAS subproject. Safety digital maps requirements', Deliverable 12.31 of the Map&ADAS subproject of the PREVENT Project, 2004
- 15 Bendaif, H., Hummelsheim, K., Sabel, H., van de Ven, S.: 'Classification of data capturing/production techniques', NextMap Project Deliverable D 3.1., 2000
- 16 Miles, J.C., Chen, K.: 'ITS handbook' (PIARC, 2004)
- 17 Yerpez, J., Ferrandez, F.: 'Road characteristics and safety. Identification of the part played by road factors in accident generation', INRETS, 1986
- 18 EDMAP Consortium: 'Enhanced digital mapping project'. Final Report, 2004
- 19 Castro, M., Iglesias, L., Rodríguez-Solano, R., Sánchez, J.A.: 'Geometric modelling of highways using global positioning system (GPS) data and spline approximation', *Transp. Res. C, Emerg. Technol.*, 2006, **14**, (4), pp. 233–243
- 20 Ben-Arieh, D., Chang, S., Rys, M., Zhang, G.: 'Geometric modelling of highways using global positioning system data and B-spline approximation', *J. Transp. Eng.*, 2004, **130**, (5), pp. 632–636
- 21 Transportation Research Board: 'Collecting, processing and integrating GPS data into GIS' (Transportation Research Board, 2002)
- 22 Naranjo, J.E., González, C., García, R., de Pedro, T.: 'ACC + Stop&Go maneuvers with throttle and brake fuzzy control', *IEEE Trans. Intell. Transp. Syst.*, 2006, **7**, (2), pp. 213–225
- 23 Imran, M., Hassan, Y., Patterson, D.: 'GPS–GIS based procedure for tracking vehicle path on horizontal alignments', *Comput.-Aided Civ. Infrastruct. Eng.*, 2006, **21**, (5), pp. 383–394
- 24 Trepagnier, P.G., Nagel, J., Kinney, P.M., Koutsougeras, C., Dooner, M.: 'KAT-5: robust systems for autonomous vehicle navigation in challenging and unknown terrain', *J. Field Robot.*, 2006, **23**, (8), pp. 509–526
- 25 Travis, W., Daily, R., Bevely, D.M., *et al.*: 'SciAutonics-Auburn engineering's low-cost high-speed ATV for the 2005 DARPA grand challenge', *J. Field Robot.*, 2006, **23**, (8), pp. 579–597
- 26 Drakopoulos, A., Örnek, E.: 'Use of vehicle-collected data to calculate existing roadway geometry', *J. Transp. Eng.*, 2000, **126**, (2), pp. 154–160
- 27 Jiménez, F., Aparicio, F., Estrada, G.: 'Measurement uncertainty determination and curve fitting algorithms for development of accurate digital maps for advanced driver assistance systems', *Transp. Res. C, Emerg. Technol.*, 2009, **17**, (3), pp. 225–239
- 28 Labrech, A., Boucher, C., Noyer, J.C.: 'Fusion of GPS and odometer measurements for map-based vehicle navigation'. Proc. IEEE Int. Conf. on Industrial Technology, Tunisia, 2004
- 29 Rezaei, S., Sengupta, R.: 'Kalman filter based integration of DGPS and vehicle sensors for localization', *IEEE Trans. Control Syst. Technol.*, 2007, **15**, (6), pp. 1080–1088
- 30 Toledo-Moreo, R., Zamora-Izquierdo, M.A., Úbeda-Miñarro, B., Gómez-Skarmeta, A.F.: 'High-integrity IMM-EKF-based road vehicle navigation with low-cost GPS/SBAS/INS', *IEEE Trans. Intell. Transp. Syst.*, 2007, **8**, (3), pp. 491–511
- 31 Xu, H., Wang, C., Yang, M., Yang, R.: 'Position estimation for intelligent vehicles using an unscented Kalman filter', *Int. J. Veh. Auton. Syst.*, 2008, **6**, (12), pp. 186–194
- 32 Gillespie, T.D.: 'Fundamentals of vehicle dynamics' (Society of Automotive Engineers, USA, 1992)
- 33 Genta, G.: 'Motor vehicle dynamics. Modeling and simulation' (World Scientific, 1999)
- 34 Wong, J.Y.: 'Theory of ground vehicles' (John Wiley and Sons, Toronto, 2001)
- 35 Nalecz, G.: 'Development and validation of light vehicle dynamics simulation (LVDS)', SAE Paper No. 920056
- 36 Vera, C., Féliz, J.: 'Dinámica vehicular basada en la técnica del Bond graph (in Spanish)' (Publications section of the ETSII, Madrid, 1994)
- 37 Day, T.D.: 'An overview of the HVE vehicle model', SAE Paper No. 950308
- 38 Mechanical Simulation Corporation: 'CARSIM 5: math models manual' (Mechanical Simulation Corporation, Michigan, 2001)
- 39 Taylor, B.N., Kuyatt, C.E.: 'Guidelines for evaluating and expressing the uncertainty of NIST measurement results' (National Institute of Standards and Technology, 1994)
- 40 European Co-Operation for Accreditation: 'Expression of uncertainty of measurement in calibration' (Publication Reference EA-4/02, 1999)